



**CRUZ catalogue**  
LCV products

**[www.cruzber.com](http://www.cruzber.com)**  
roof racks & accessories

## SINCE 1963

CRUZBER SA is one of the leading manufacturers of roof racks and roof bars in the European market with a complete range of solutions for passenger cars, offroad vehicles and commercial vans. Its headquarters and central warehouses are located in the province of Córdoba (Spain), with a surface area of more than 12000m<sup>2</sup>. The CRUZ brand leads the Spanish market and is present in over 30 countries, developing and adapting its products to the specific needs of each market.

CRUZBER SA is awarded the certification of the Quality Management System based on ISO 9001:2015 for its efficiency in the operating procedures and organization. This certification is awarded to all its business processes, ranging from the development of products, manufacture, marketing and logistics to customer services.

Manufacture under strict compliance with the latest directives of the European Union, as well as certifications for specific countries. Since its foundation, quality methods and highly qualified staff constitute CRUZBER SA's most important, essential values. R&D: new advanced anticorrosion treatments, based on nanotechnology, Warranty exceeding 1000 hours in a saline fog chamber. The use of super durable polymers and paints with non-slip properties offer maximum resistance to harsh weather conditions. Every new product developed is tested under standard DIN 75302:1991. Ongoing adaptation and improvement of production processes to achieve more environmentally aware processes.

## AN EFFICIENT, ADAPTABLE SYSTEM

CRUZBER SA is the main supplier of transport systems for the leading renting-leasing operators and commercial van equipment companies in the Spanish market. The CRUZ roof rack and roof bar system is made to fit most commercial vans in the market, and designed to satisfy the demands of original equipment and company fleets. At CRUZBER SA we adapt to our clients' specific needs, working together with our R&D department in the development and adaptation of products to their requirements. Our goal is to customise, adapt and develop products in order to offer an optimal solution to each specific need.

# ROOF RACKS & ACCESSORIES

The CRUZ logo is a white oval with a blue border containing the word "CRUZ" in blue capital letters.



**aluminium roof bars**

CRUZ Alu Cargo .....06  
 CRUZ Alu Cargo AF .....08  
 CRUZ aluminium extensible roller.....08  
 CRUZ Alu Cargo system.....10  
 CRUZ Alu Cargo system accessories .....11



**steel roof bars**

CRUZ Cargo Xpro .....12  
 CRUZ Cargo Xpro SF .....14  
 CRUZ Cargo Xpro system.....14  
 CRUZ Cargo Xpro system accessories.....15  
  
 CRUZ Cargo Spro .....16  
 CRUZ Oplus SR+ .....17  
 CRUZ Cargo Spro system .....18  
 CRUZ Cargo Spro system accessories .....19  
 CRUZ rear door ladder type B .....20  
  
 general accessories for roof bars .....21



**aluminium roof racks**

CRUZ Evo Rack Alu .....24  
 CRUZ Evo Rack Alu module .....26  
 CRUZ Evo Rack Alu system .....26  
 CRUZ Evo Rack Alu system accessories.....27



**steel roof racks**

CRUZ Evo Rack Pro .....28  
 CRUZ Evo Rack Pro system .....30  
 CRUZ Evo Rack Pro system accessories .....31  
  
 CRUZ Evo Rack .....32  
 CRUZ Evo Rack module .....34  
 CRUZ Evo Rack system .....34  
 CRUZ Evo Rack system accessories .....35  
  
 CRUZ Safari .....38  
 CRUZ Safari accessories .....40  
 CRUZ Safari system accessories .....41  
 CRUZ rear door ladder type EF .....42  
  
 general accessories for roof racks.....43

**CRUZ info & support**

other languages .....44  
 CRUZ info & support .....50  
 CRUZmedia support



**CRUZ WARRANTY**

The CRUZ brand offers exceptional products with proven quality and an extended warranty against defects in material and workmanship.

- es La marca CRUZ ofrece unos productos excepcionales con una calidad probada y una garantía extendida frente a defectos de material y mano de obra.
- fr La marque CRUZ propose des produits exceptionnels avec une qualité éprouvée et une garantie prolongée contre les défauts de matériaux et de fabrication.
- de Die Marke CRUZ bietet außergewöhnliche Produkte mit bewährter Qualität und einer erweiterten Garantie gegen Material- und Verarbeitungsfehler.

	■	(code)	—	✓
en	included	optional	no available	available
es	incluido	opcional	no disponible	disponible
fr	inclus	optionnel	non disponible	disponible
de	serie	optional	nicht lieferbar	lieferbar
...	other languages □ 44			





INDEX ←



CRUZ Alu Cargo Dark AF  
CRUZ Kit LCV

**Aluminium reinforced load carrier bars. 3-slot profile.**

Reinforced aluminum profile with three slots for easy mounting of accessories. Enhanced aerodynamic shape, streamlined and functional design. Maximum corrosion resistance. Ergonomy: professional safety to load the material onto the roof.

- es Barras portacargas de aluminio reforzadas. Perfil de 3 ranuras. Perfil reforzado de aluminio con tres ranuras para fácil acoplamiento de accesorios. Excelente aerodinámica y diseño elegante y funcional. Mayor resistencia y protección anticorrosiva. Ergonomía: seguridad profesional para la carga del material sobre el techo.
- fr Barres porte tout en aluminium renforcé. Profil de 3 fentes. Profil renforcé en aluminium avec 3 fentes pour installer très facilement des accessoires. Excellent aérodynamique et design élégant et fonctionnel. Résistance et protection anticorrosive supérieures. Ergonomie: sécurité professionnelle pour la charge du matériel sur le toit.
- de Verstärkte Aluminium-Dachträger. Dreikanalprofil. Verstärktes Aluminium-Dreikanalprofil zur leichten Montage von Zubehör. Ausgezeichnete Aerodynamik mit attraktivem funktionellem Design. Sehr robust und höchster Korrosionsschutz. Ergonomie: professionelles Sicherheitsniveau zur Ladung von Material auf dem Fahrzeugdach.
- ... **other languages** 44

		<sup>1</sup>				Kit	roof type <sup>4</sup>	Max: Kit type <sup>2</sup>		
924-xxx	CRUZ Alu Cargo	■ —	52x35	1180–1580	□	■ □	B–F–C	150	932-0xx	
924-xxx	CRUZ Alu Cargo X/T	■ —	52x35	1180–1330	□	■ —	B–F–C	75	932-01x	
925-xxx	CRUZ Alu Cargo Dark X/T	■ —	52x35	1180–1330	□	■ —	B–F–C	75	932-01x	
924-x6x	CRUZ Alu Cargo R	■ —	52x35	1280–1480	■	■ —	R	75	—	
924-x9x	CRUZ Alu Cargo AF	■ —	52x35	1180–1580	■	■	933-xxx 934-xxx B–F–C V	150	—	
925-xxx	CRUZ Alu Cargo Dark AF	■ —	52x35	1180–1580	■	■	933-xxx 934-xxx B–F–C V	150	—	

<sup>1</sup> mm, <sup>2</sup> Kg, <sup>3</sup> x4, <sup>4</sup> □ 8, <sup>5</sup> silver aluminium/black aluminium

- Aluminium 6063/T6
- Matt anodized

- Pickling steel
- Oxsilan
- HQ Polymer class 2

- silver aluminium
- black aluminium

- 
- CRUZ Alu Cargo AF
- CRUZ Kit LCV
- CRUZ ladder fixation
- CRUZ extended Alu Cargo roller
- CRUZ straps

INDEX ←

CRUZ Alu Cargo  
CRUZ Alu Cargo AF

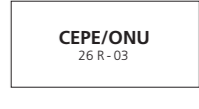
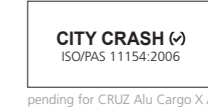



INDEX ←



**Aluminium extensible roller for CRUZ Alu Cargo bars**

The aluminium extensible roller is a perfect accessory for CRUZ Alu Cargo roof bars to facilitate loading and unloading of material. At the same time, the use of an extensible roller protects the vehicle against knocks and scratches when loading and unloading of material. Made of stainless steel to guarantee a greater durability.

- es Rulo extensible de aluminio para barras de techo CRUZ Alu Cargo. El rulo extensible de aluminio es un complemento perfecto de las barras de techo CRUZ Alu Cargo para facilitar la carga y descarga de material. A su vez, el uso del rulo extensible protege el vehículo ante golpes y arañazos al cargar o descargar material. El rulo está fabricado en acero inoxidable para garantizar una mayor durabilidad.
  - fr Rouleau extensible en aluminium pour barres de toit CRUZ Alu Cargo. Le rouleau extensible en aluminium est l'accessoire parfait pour les barres de toit CRUZ Alu Cargo, pour aider à la manipulation de charge et décharge du matériel. Au même temps, l'utilisation du rouleau extensible protège le véhicule face des coups et égratignures dus à la manipulation de charge et décharge du matériel. Le rouleau est fabriqué en acier inoxydable afin de garantir sa durabilité.
  - de Längsverstellbare Laderolle für CRUZ Alu Cargo Aluminium-Dachträger. Die längsverstellbare Aluminiumrolle von CRUZ, ist das ideale Zubehör der CRUZ Alu Cargo Aluminium-Dachträger, und ermöglicht ein leichtes Beladen und Entladen des Materials. Zusätzlich schützt die längsverstellbare Laderolle das Fahrzeug vor Beulen und Schrammen, die während des Be- und Entladens entstehen können. Die Laderolle ist aus rostfreiem Stahl hergestellt um eine maximale Haltbarkeit zu gewährleisten.
- ... **other languages** [44](#)

		↔ <sup>1</sup>	INOX 304
941-192	2 aluminium extensible roller supports + 60 cm inox roller	600	■
941-193	2 aluminium extensible roller supports + 80 cm inox roller	800	■

<sup>1</sup> mm



- 
- - CRUZ Alu Cargo AF
- CRUZ Kit LCV
- CRUZ aluminium extensible roller

INDEX ←

CRUZ aluminium extensible roller



INDEX ←

CRUZ Alu Cargo



■ silver aluminium  
■ black aluminium



CRUZ Alu Cargo    CRUZ Alu Cargo X/T CRUZ Kit Optiplus    CRUZ Alu Cargo R

CRUZ Alu Cargo AF



■ silver aluminium  
■ black aluminium



CRUZ Alu Cargo AF CRUZ Kit LCV    CRUZ Alu Cargo AF CRUZ Kit V    CRUZ Alu Cargo AF

roof types



CRUZ Alu Cargo AF, CRUZ Kit LCV



CRUZ Alu Cargo T



CRUZ Alu Cargo R



CRUZ Alu Cargo AF, CRUZ Kit V

INDEX ←

CRUZ Alu Cargo system accessories



- |   |         |                                    |
|---|---------|------------------------------------|
| 1 | 932-01x | CRUZ anti-theft key locks          |
| 2 | 941-310 | CRUZ M8 eye bolts                  |
| 3 | 932-050 | CRUZ anti-theft end caps 52x35     |
| 4 | 941-4xx | CRUZ foldable load stops Alu Cargo |





INDEX ←



















CRUZ Cargo Xpro SF  
CRUZ Kit LCV

**Roof bars in galvanized steel, 35x35 mm reinforced profile**



Steel load carriers for vans. Rectangular galvanized steel profile, covered with high quality polymers. Extra heavy duty load carriers. Efficient anti-corrosion protection. All types of accessories are easily fitted.



- es Barras de techo en acero galvanizado reforzado de 35x35. Barras porta cargas de acero para furgones. Perfil rectangular de acero galvanizado, recubierto con polímeros de alta calidad. Resistentes y con una eficaz protección anticorrosiva. Fácil montaje de todo tipo de accesorios.
- fr Barres de toit en acier galvanisé renforcé de 35x35. Barres porte-charges en acier pour fourgons. Profil rectangulaire en acier galvanisé, recouvert de polymères de grande qualité. Extrêmement robuste et protection anticorrosion efficace. Montage facile de tous types d'accessoires.
- de Verzinkter Stahl-Dachträger (35x35). Stahl-Dachträger für Nutzfahrzeuge. Galvanisiertes verstärktes Stahl-Vierkantprofil, beschichtet mit hochwertigen Polymeren. Sehr robust und wirksamer Korrosionsschutz. Leichte Montage von Zubehör.
- ... **other languages** [44](#)







										
		1	1				Kit	roof type 4	Max: Kit type 2	3
923-xxx	CRUZ Cargo Xpro	35x35x1.5	1250-1750					B-F-C	150	932-0xx
923-0xx	CRUZ Cargo Xpro SF	35x35x1.5	1250-1750				933-xxx 934-xxx	B-F-C V	150	932-0xx <sup>5</sup>

<sup>1</sup> mm, <sup>2</sup> Kg, <sup>3</sup> x4, <sup>4</sup> 14, <sup>5</sup> not available for V-type kit

-  - Galvanized steel Z275
-  - Cover LDPE

-  - Pickling steel
-  - Oxsilan
-  - HQ Polymer class 2

-  silver aluminium
-  black aluminium

- 
-  - CRUZ Cargo Xpro SF
-  - CRUZ Kit LCV
-  - CRUZ load stops
-  - CRUZ extended roller
-  - CRUZ straps

INDEX ←

CRUZ Cargo Xpro  
CRUZ Cargo Xpro SF



INDEX ←

CRUZ Cargo Xpro



CRUZ Cargo Xpro SF



CRUZ Cargo Xpro SF  
CRUZ Kit LCV

CRUZ Cargo Xpro SF  
CRUZ Kit V

CRUZ Cargo Xpro SF

roof types



CRUZ Cargo Xpro SF, CRUZ Kit LCV



CRUZ Cargo Xpro SF, CRUZ Kit V

INDEX ←

CRUZ Cargo Xpro system accessories



- 1 932-01x CRUZ anti-theft key locks
- 2 941-03x CRUZ load stops CRUZ Cargo Xpro
- 3 941-22x CRUZ deflector CRUZ Cargo Xpro
- 4 941-188 CRUZ 2x extended roller supports CRUZ, Cargo Xpro
- 5 941-03x CRUZ pipe clamps CRUZ Cargo Xpro



INDEX ←



## CRUZ Cargo Spro

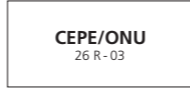
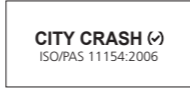

### Roof bars in galvanized steel, 30x20 mm reinforced profile

Steel load carriers for vans. Rectangular galvanized steel profile, covered with high quality polymers. Extra heavy duty load carriers. Efficient anti-corrosion protection. All types of accessories are easily fitted.

- es Barras de techo en acero galvanizado reforzado de 30x20. Barras porta cargas de acero para furgonetas. Perfil rectangular de acero galvanizado, recubierto con polímeros de alta calidad. Resistentes y con una eficaz protección anticorrosiva. Fácil montaje de todo tipo de accesorios.
- fr Barres de toit en acier galvanisé renforcé de 30x20. Barres porte-charges en acier pour fourgons. Profil rectangulaire en acier galvanisé, recouvert de polymères de grande qualité. Extrêmement robuste et protection anticorrosion efficace. Montage facile de tous types d'accessoires.
- de Verzinkter Stahl-Dachträger (30x20). Stahl-Dachträger für Nutzfahrzeuge. Galvanisiertes verstärktes Stahl-Vierkantprofil, beschichtet mit hochwertigen Polymeren. Sehr robust und wirksamer Korrosionsschutz. Leichte Montage von Zubehör.

... other languages 44



922-xxx	CRUZ Cargo Spro	30x20x1.5	1050-1200	□	■	■	■	Kit	roof type <sup>4</sup>	Max: Kit type <sup>2</sup>	932-0xx
<sup>1</sup> mm, <sup>2</sup> Kg, <sup>3</sup> x4, <sup>4</sup> 18											

- Galvanized steel Z275
- Cover LDPE

- Pickling steel
- Oxsilan
- HQ Polymer class 2

- ←
- CRUZ Cargo Spro

INDEX ←



## CRUZ Oplus SR+



### Roof bars in galvanized steel, 30x20x1.5 mm reinforced profile

Steel load carriers for vans. Rectangular galvanized steel profile, covered with high quality polymers. Extra heavy duty load carriers. Efficient anti-corrosion protection. All types of accessories are easily fitted.

- es Barras de techo en acero galvanizado reforzado de 30x20x1.5. Barras porta cargas de acero para furgonetas. Perfil rectangular de acero galvanizado, recubierto con polímeros de alta calidad. Resistentes y con una eficaz protección anticorrosiva. Fácil montaje de todo tipo de accesorios.
- fr Barres de toit en acier galvanisé renforcé de 30x20x1.5. Barres porte-charges en acier pour fourgons. Profil rectangulaire en acier galvanisé, recouvert de polymères de grande qualité. Extrêmement robuste et protection anticorrosion efficace. Montage facile de tous types d'accessoires.
- de Verzinkter Stahl-Dachträger (30x20x1.5). Stahl-Dachträger für Nutzfahrzeuge. Galvanisiertes verstärktes Stahl-Vierkantprofil, beschichtet mit hochwertigen Polymeren. Sehr robust und wirksamer Korrosionsschutz. Leichte Montage von Zubehör.

... other languages 44



921-xxx	CRUZ Oplus SR+	30x20x1.5	1100-1500	□	■	■	■	Kit	roof type <sup>4</sup>	Max: Kit type <sup>2</sup>	932-034
<sup>1</sup> mm, <sup>2</sup> Kg, <sup>3</sup> x4, <sup>4</sup> 16											

- Galvanized steel Z275
- Cover LDPE

- Pickling steel
- Oxsilan
- HQ Polymer class 2

- ←
- CRUZ Oplus SR+
- CRUZ ladder fixation

INDEX ←

CRUZ Cargo Spro



CRUZ Oplus SR+



roof types



CRUZ Cargo Spro



CRUZ Oplus SR+

INDEX ←

CRUZ Cargo Spro system accessories



- |   |         |  |
|---|---------|--|
| 1 | 932-01x | CRUZ anti-theft key locks                        |
| 2 | 932-034 | CRUZ anti-theft end caps SR+                     |
| 3 | 941-03x | CRUZ pipe clamps CRUZ Cargo Spro                 |
| 4 | 941-0xx | CRUZ load stops CRUZ Cargo Spro                  |
| 5 | 941-186 | CRUZ 2x extended roller supports CRUZ Cargo Spro |

INDEX ←

## CRUZ rear door ladder type B

**DIN 51130**  
Anti-slip R11

### Access ladder for the rear door

Ladder to access the roof rack and to be fitted on the rear door of the van. Suitable to all types of doors, not being necessary to drill the vehicle. It is possible to fit on vans with windows on the rear doors. This ladder is more rigid thanks to larger tubes. Textured anti-slip finish. It meets anti-slip standards DIN 51130; Anti-slip R11. Necessary to assemble the CRUZ Kit rear door ladder specific to each vehicle. Not suitable for vans with tailgate.

es Escalera de acceso para la puerta trasera. Escalera para acceder al portaequipajes del vehículo de colocación sobre la puerta trasera de la furgoneta. Adaptable a todo tipo de puertas sin necesidad de realizar perforaciones. Posibilidad de colocación incluso en furgonetas con puerta trasera acristalada. Mayor rigidez gracias a los tubos de mayor sección. Acabado en pintura rugosa anti-deslizamiento. Cumple normativa anti-deslizamiento DIN 51130; Anti-slip R11. Necesario para su montaje el CRUZ Kit rear door ladder específico para cada vehículo. No compatible con portón trasero.

fr Échelle porte-arrière. Compatible avec tout type de portes, sans perforation. Il est possible d'installer sur les portes vitrées. Plus de rigidité, grâce à la construction en tubes de section majeur. Revêtement en peinture antidérapante. Accomplissement de la Norme Anti Derapante DIN 51130; Anti-slip R11. Échelle porte-arrière. Échelle pour accéder à la galerie, d'installation sur la porte-arrière du véhicule. Compatible avec tout type de portes, sans perforation. Il est possible d'installer sur les portes vitrées. Plus de rigidité, grâce à la construction en tubes de section majeur. Revêtement en peinture antidérapante. Accomplissement de la Norme Anti Derapante DIN 51130; Anti-slip R11. Indispensable le CRUZ Kit rear door ladder spécifique à chaque véhicule. Pas compatible avec des véhicules avec hayon.

de Hecktürleiter. Hecktürleiter für den sicheren Aufstieg zum Gepäckträger des Nutzfahrzeugs. Kompatibel mit allen Heckflügeltüren, ohne Bohren. Montagemöglichkeit auch an Nutzfahrzeugen mit Heckfenster. Höhere Steifigkeit durch ein größeres Schnittprofil. Oberflächenbeschaffenheit: Anti-Rutsch schwarz strukturiert. Die Leiter erfüllt die DIN-Norm 51130; Klasse der Rutschhemmung R11. Für die Montage wird das für jedes Fahrzeug spezifische CRUZ Kit Rear Door Ladder benötigt. Nicht kompatibel mit Heckklappen.

... other languages 44

			Max: <sup>2</sup>		
941-072	CRUZ rear door ladder type B 155	1550	100	✓	— <sup>3</sup>
941-074	CRUZ rear door ladder type B 185	1850	100	✓	— <sup>3</sup>
941-076	CRUZ rear door ladder type B 208	2080	100	✓	— <sup>3</sup>

<sup>1</sup> mm, <sup>2</sup> Kg, <sup>3</sup> not suitable for vans with tailgate

- Pickling steel
- Oxsilan
- HQ Polymer class

- ←
- CRUZ rear door ladder type B
- CRUZ Cargo Xpro
- CRUZ load stops
- CRUZ extended roller
- CRUZ ratchet straps



INDEX ←

### general accessories for roof bars

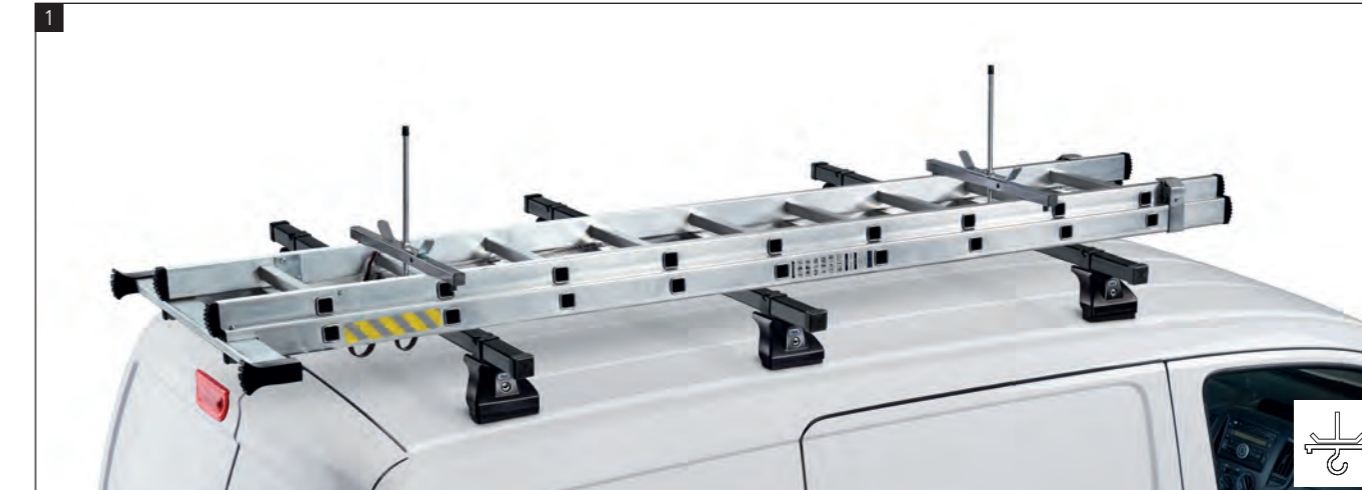

- 1 941-04x CRUZ ladder clamps
- 2 941-304 CRUZ ratchet strap with S hook
- 3 994-8xx CRUZ Alu Side
- 4 941-06x CRUZ rear door ladder type EF

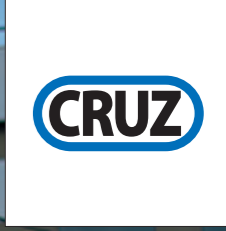

# DESIGNED TO MEET THE NEEDS OF PROFESSIONAL USERS ↘

es | Diseñados para satisfacer las necesidades del usuario profesional  
fr | Développés pour satisfaire les besoins des professionnels  
de | Entwickelt, um die Bedürfnisse professioneller Anwender zu erfüllen





INDEX ←



- aerodynamic design with mat anodized aluminium



CRUZ Evo Rack Alu module  
CRUZ Kit LCV

**Ergonomic roof rack made of matt anodized aluminium**

Roof rack exclusively made of aluminium, with a compact, robust and ergonomic design. Innovative system which allows a quick fitting of crossbars, now made of aluminium, with an aerodynamic design and t-tracks in the back to fit accessories. Lateral profiles with two longitudinal slots ensuring a greater flexibility to fit all models of vehicles.

- es Portaequipajes ergonómico fabricado en aluminio anodizado mate. Portaequipajes fabricado completamente en aluminio con diseño compacto, robusto y ergonómico. Innovador sistema de fijación rápida de los tubos de parrilla, ahora en aluminio, con diseño aerodinámico y carril posterior para el acoplamiento de accesorios. Perfiles laterales con doble ranura para una mayor flexibilidad y ajuste a cada modelo de vehículo.
- fr Galerie ergonomique fabriquée entièrement en aluminium anodisé mat. Galerie fabriquée entièrement en aluminium, avec un design compact, robuste et ergonomique. Novateur système de fixation rapide des tubes transversaux en aluminium, avec design aérodynamique et profil postérieur pour y installer des accessoires. Profils latéraux avec double fente pour plus de flexibilité et adaptation à chaque modèle de véhicule.
- de Ergonomischer Dachgepäckträger aus matt eloxiertem Aluminium. Aluminium-Dachgepäckträger mit kompaktem, robustem und ergonomischem Design. Innovatives Einschieben der Aluminium-Traversen am inneren Trägerkanal der neuen Seitenrahmenprofile des Dachgepäckträgers, mit aerodynamischem Design und einem auf der Rückseite befindlichem Kanal zur leichten Montage von Zubehör. 2-Kanal Seitenrahmenprofile für höhere Flexibilität und Anpassung an jeden Fahrzeugtyp.

... other languages □ 44

		L <sup>1</sup>	W <sup>1</sup>	Kit	roof type <sup>4</sup>	Max: Kit type <sup>2</sup>					
911-xxx	CRUZ Evo Rack Alu	1300-4800	1100-1700	■	B-F-C	180	■	■	932-01x	✓	✓
912-xxx	CRUZ Evo Rack Alu module	1300-4800	1100-1700	933-xxx 934-xxx	B-F-C V	180	■	■	932-01x <sup>5</sup>	✓	✓

<sup>1</sup> mm, <sup>2</sup> Kg, <sup>3</sup> x4, <sup>4</sup> □ 26

- Aluminium 6063/T6
- Matt anodized

- Pickling steel
- Oxsilan
- HQ Polymer class 2

- 
- - CRUZ Evo Rack Alu module
- CRUZ Kit LCV
- CRUZ load stops
- CRUZ walkway

INDEX ←

CRUZ Evo Rack Alu  
CRUZ Evo Rack Alu module





INDEX ←

CRUZ Evo Rack Alu system

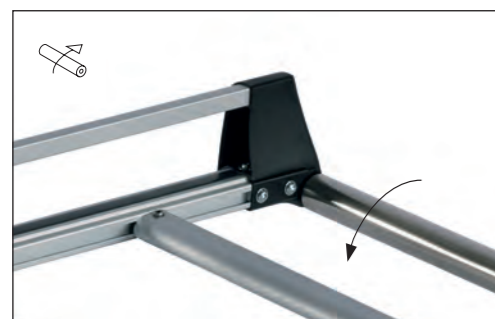
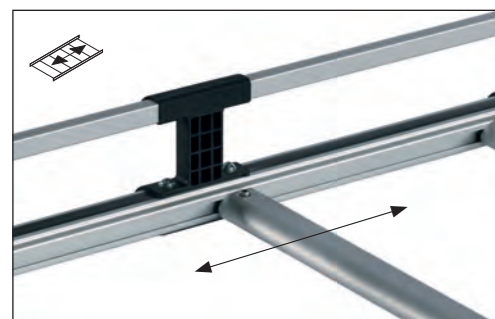

roof types

F C B V



CRUZ Evo Rack Alu module  
CRUZ Kit LCV

INDEX ←

CRUZ Evo Rack Alu system accessories

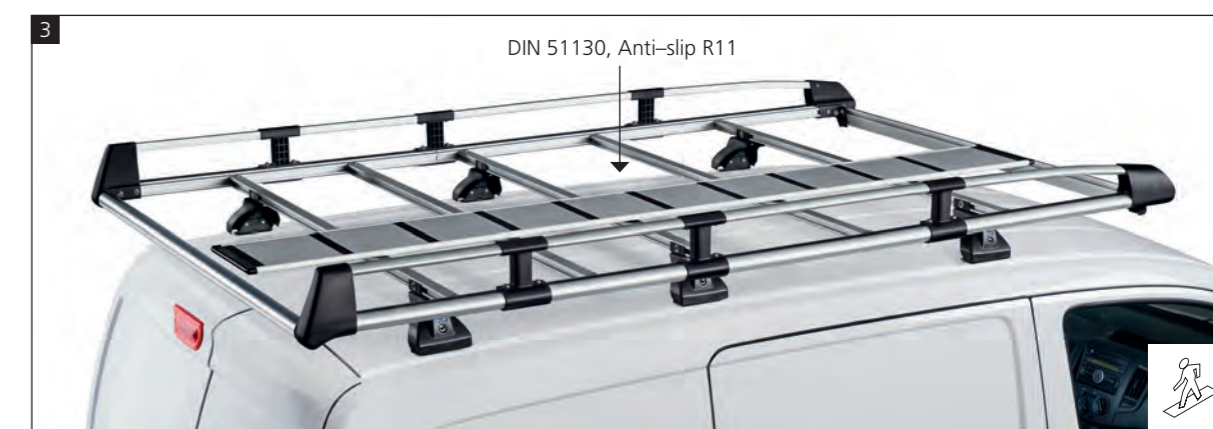

- 1 932-01x CRUZ anti-theft locks
- 2 941-00x CRUZ load stops Evo Rack Alu
- 3 941-5xx CRUZ walkway Evo Rack Alu



INDEX ←



- specially robust and ergonomic structure



**Specially robust and ergonomic roof racks made of galvanized steel**

Great strength of its structure thanks to the fact that it has been especially designed for all models of vehicles and larger dimensions. Higher resistance to extreme weather conditions because it is made of galvanized steel. Better aerodynamics thanks to a new aluminium wind deflector. Higher side rails, guaranteeing a greater security of the load carried.

- es Portaequipajes de acero galvanizado extremadamente robusto y ergonómico. Gran rigidez estructural gracias a que han sido diseñados específicamente para cada modelo de vehículo y contar con perfiles de mayor sección. Mayor resistencia a condiciones climáticas extremas gracias a estar fabricados en acero galvanizado. Mejor aerodinámica gracias al nuevo deflector de aluminio. Barandillas laterales de mayor altura, lo que garantiza una mayor seguridad de la carga transportada.
  - fr Galerie en acier galvanisé extrêmement robuste et ergonomique. Structure plus rigide grâce aux profils plus larges et le redimensionnement complet des galeries adaptées à chaque modèle de véhicule. Plus résistant aux conditions climatiques sévères grâce à l'acier galvanisé. Aérodynamique améliorée grâce au design de la galerie et le nouveau déflecteur en aluminium. Rampes latérales plus élevées, ce qui permet de mieux sécuriser la charge.
  - de Verzinkter Stahl-Dachgepäckträger extrem robust und ergonomisch. Die robuste Struktur – jetzt mit größerem Schnittprofil – ist speziell für jedes Fahrzeugmodell konstruiert. Hergestellt aus verzinktem Stahl, für erhöhte Beständigkeit und als Schutz gegen extreme Wetterbedingungen. Bessere Aerodynamik durch serienmäßigen Frontspoiler aus Aluminium. Höhere Seitenrahmenprofile, um eine größere Sicherheit der Ladung zu garantieren.
- ... other languages 44

	L <sup>1</sup>	W <sup>1</sup>	Kit	roof type <sup>4</sup>	Max: Kit type <sup>2</sup>		
913-xxx CRUZ Evo Rack Pro	1800–4400	1100–1700	■	B–F–C	180	■ ■	932-01x ✓ — <sup>5</sup>

<sup>1</sup> mm, <sup>2</sup> Kg, <sup>3</sup> x4, <sup>4</sup> □ 30, <sup>5</sup> not available for V-type kit

- Galvanized steel
- Oxsilan
- HQ Polymer class 2

- Pickling steel
- Oxsilan
- HQ Polymer class 2

- 
- CRUZ Evo Rack Pro
- CRUZ load stops
- CRUZ walkway
- CRUZ rear door ladder type B

INDEX ←

CRUZ Evo Rack Pro



INDEX ←

CRUZ Evo Rack Pro



roof types



INDEX ←

CRUZ Evo Rack Pro system accessories



- 1 932-01x CRUZ anti-theft key locks
- 2 941-01x CRUZ load stops Evo Rack Pro
- 3 941-26x CRUZ walkway Evo Rack Pro





INDEX ←



- roller and wind deflector included



CRUZ Evo Rack module  
CRUZ Kit LCV

**Galvanized steel roof rack with a compact, robust and an ergonomic design**

Higher resistance to extreme weather conditions as it is made of galvanized steel. Robust structure with a new design which provides a greater rigidity to the set. Innovative quick fitting system of the crossbars of the roof racks; these crossbars, together with the new design of the side tubes with open inner rails, improve the assembly time. The dimensions have been fully redesigned so that it can adapt better to each type of vehicle.

- es Portaequipajes de acero galvanizado con diseño compacto, robusto y ergonómico. Mayor resistencia a duras condiciones climáticas gracias a estar fabricado en acero galvanizado. Robusta estructura con nuevo diseño que confiere una mayor rigidez al conjunto. Innovador sistema de fijación rápida de los tubos parrilla que, unidos al nuevo diseño de tubos laterales con carril interior continuo, mejoran el tiempo de montaje. Completo rediseño de medidas para mejor adaptación a cada modelo de vehículo.
  - fr Galerie en acier galvanisé avec un design compact, robuste et ergonomique. Plus résistant aux conditions climatiques sévères grâce à l'acier galvanisé. Structure plus robuste avec un nouveau design lequel offre plus rigidité à la galerie. Système novateur de fixation rapide des tubes transversaux qui avec le nouveau design des tubes longitudinaux disposant de profil intérieur continu, permettent de réduire le temps d'installation. Esthétique améliorée par rapport aux modèles précédents, plus proche aux modèles de véhicules actuels, avec finition de peinture texturisée.
  - de Verzinkter Stahl-Dachgepäckträger mit kompaktem, robustem und ergonomischem Design. Hergestellt aus verzinktem Stahl, für erhöhte Beständigkeit und als Schutz gegen extreme Wetterbedingungen. Eine robuste Struktur mit neuem Design garantiert eine höhere Verwindungssteifigkeit. Geringe Montagezeit durch innovatives Einschieben der Vierkantraversen am inneren Trägerkanal der neuen Seitenrahmenprofile des Dachgepäckträgers. Die neuen Abmessungen des Dachgepäckträgersystems passen perfekt zu jeden Fahrzeugtyp.
- ... other languages 44

		L <sup>1</sup>	W <sup>1</sup>	Kit	roof type <sup>4</sup>	Max: Kit type <sup>2</sup>					
909-xxx	CRUZ Evo Rack	1300-4800	1100-1700	■	B-F-C	180	■	□	932-01x	✓	✓
910-xxx	CRUZ Evo Rack module	1300-4800	1100-1700	933-xxx 934-xxx	B-F-C V	180	■	□	932-01x	✓	✓

<sup>1</sup> mm, <sup>2</sup> Kg, <sup>3</sup> x4, <sup>4</sup> 34

- Galvanized steel
- Oxsilan
- HQ Polymer class 2

- Pickling steel
- Oxsilan
- HQ Polymer class 2

- 
- CRUZ Evo Rack module
- CRUZ Kit LCV
- CRUZ roller
- CRUZ load stops
- CRUZ walkway

INDEX ←

CRUZ Evo Rack  
CRUZ Evo Rack module



INDEX ←

CRUZ Evo Rack

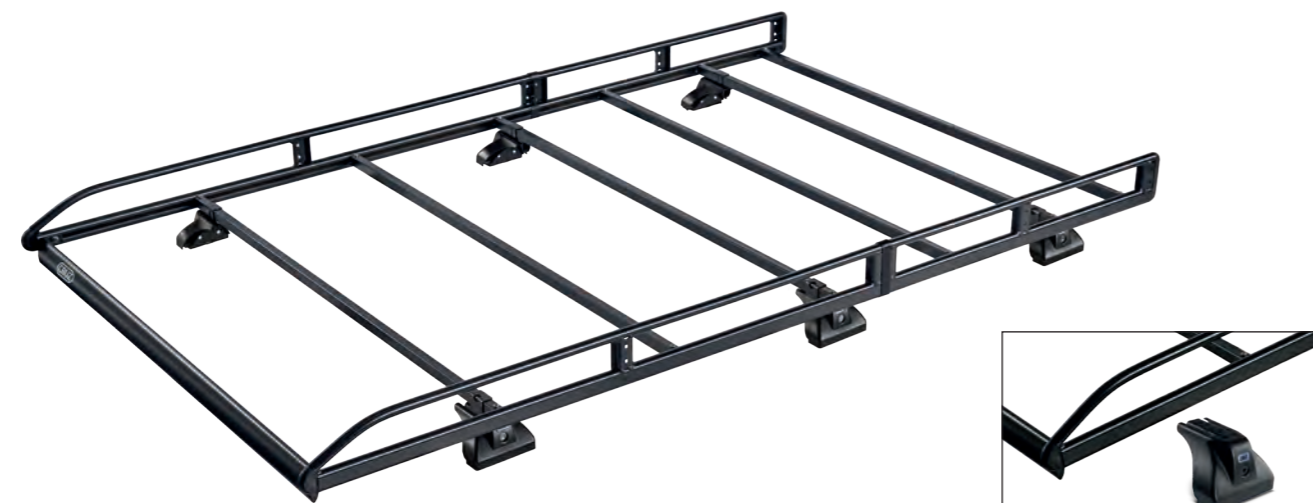
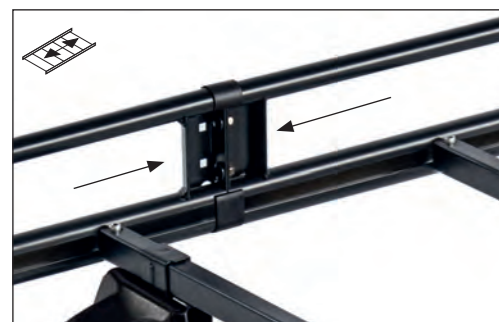

CRUZ Evo Rack module  
CRUZ Kit LCV

roof types

F C B V



INDEX ←

CRUZ Evo Rack system accessories

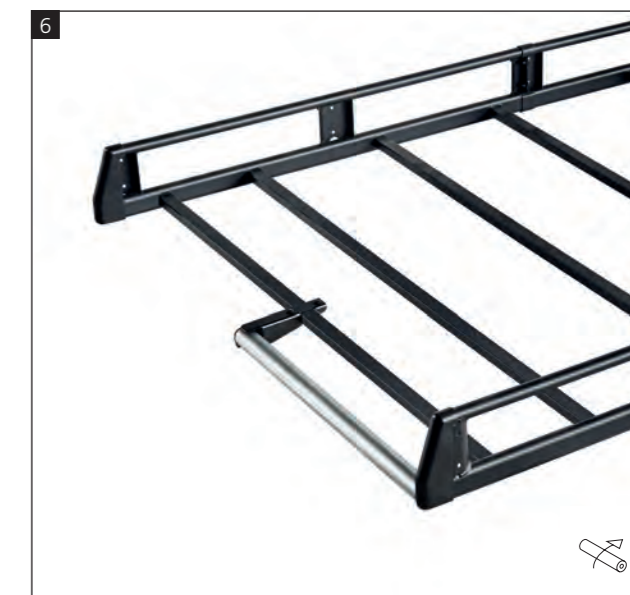
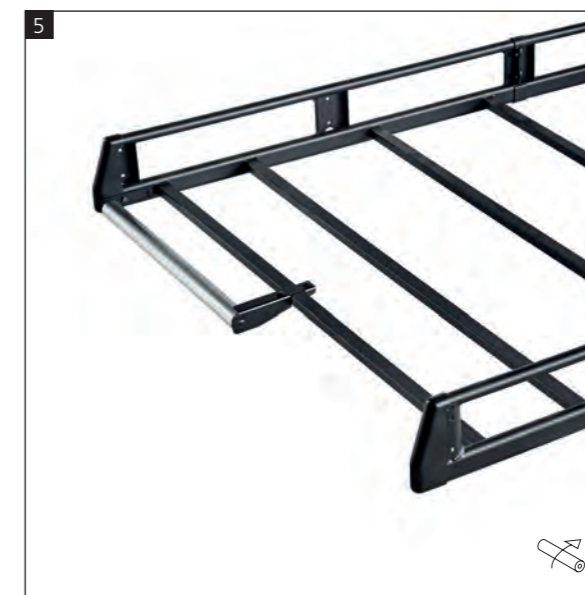

- |   |         |  |
|---|---------|--|
| 1 | 932-01x | CRUZ anti-theft locks                      |
| 2 | 941-00x | CRUZ load stops Evo Rack                   |
| 3 | 941-1xx | CRUZ roller Evo Rack                       |
| 4 | 941-430 | CRUZ walkway Evo Rack                      |
| 5 | 941-431 | CRUZ half roller supports (left) Evo Rack  |
| 6 | 941-26x | CRUZ half roller supports (right) Evo Rack |



# FOR THE DAY BY DAY OF PROFESSIONALS ↘

es | Para el día a día del profesional  
fr | Pour aider les travailleurs  
de | Für den Berufsalltag





INDEX ←



- specially designed for 4x4 vehicles



**Roof rack module specially designed for 4x4 vehicles**

The CRUZ Safari roof rack module is strong and long-lasting, with a large load capacity. Its design includes rails all around its perimeter and an integrated deflector for a better aerodynamics and safety. Wide variety of specific accessories, compatible with all steel CRUZ roof racks and designed to meet the needs of the user of 4x4 vehicles.

- es Módulo portaequipajes especialmente diseñado para vehículos 4x4. El módulo CRUZ Safari es un portaequipajes robusto, duradero y con gran capacidad de carga. Su diseño incluye barandillas por todo su perímetro y un deflector integrado de serie para una mejor aerodinámica y seguridad. Gran variedad de accesorios específicos, compatibles con resto de portaequipajes CRUZ de acero, y diseñados para satisfacer las necesidades del usuario de vehículos 4x4.
  - fr Galerie modulaire spécifiquement conçue pour les véhicules 4x4. La galerie modulaire CRUZ Safari est robuste et durable, avec une grande capacité de charge. Son design inclut des rails autour de son périmètre et un déflecteur intégré pour une meilleure aérodynamique et sécurité. Grande variété d'accessoires spécifiques compatibles avec le reste des galeries CRUZ en acier, conçus pour répondre aux besoins des usagers des véhicules 4x4.
  - de Gepäckträgermodul speziell konzipiert für Allrad-Fahrzeuge. Das Modul CRUZ Safari ist ein robuster, haltbarer Gepäckträger mit großer Nutzlast. Zum Design gehören rundum verlaufende Geländer und ein serienmäßig integrierter Deflektor für bessere Aerodynamik und mehr Sicherheit. Große Auswahl an Spezialzubehör, das mit den übrigen CRUZ Stahl-Gepäckträgern kompatibel ist und den Bedürfnissen der Nutzer von Geländefahrzeuge gerecht wird.
- ... other languages [44](#)

		↔ L <sup>1</sup>	↔ W <sup>1</sup>	⚙️ Kit	ℹ️ roof type <sup>4</sup>	⬇️ Max: Kit type	🚙	🚚	🚛
901-9xx	CRUZ Safari	1325-2625	1100-1400	933-xxx	V	180	■	✓	✓

<sup>1</sup> mm, <sup>2</sup> Kg, <sup>3</sup> x4, <sup>4</sup> □ 40

- ⚙️ - Galvanized steel
- Oxsilan
- HQ Polymer class 2

- ⚙️ - Pickling steel
- Oxsilan
- HQ Polymer class 2

- 
- ⚙️ - CRUZ Safari
- CRUZ Kit V
- CRUZ load stops
- CRUZ foldable ladder
- CRUZ walkway

INDEX ←

CRUZ Safari

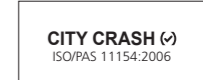

INDEX ←



roof types



INDEX ←

CRUZ Safari system accessories



- |   |         |                      |
|---|---------|----------------------|
| 1 | 941-05x | CRUZ foldable ladder |
| 2 | 941-26x | CRUZ walkway         |
| 3 | 941-00x | CRUZ load stops      |

INDEX ←



## CRUZ rear door ladder type EF

**DIN 51130**  
Anti-slip R11

### Rear door fixed ladder

Fixed ladder to access the roof rack, assembled on the rear door of commercial vehicles. Textured anti-slip finish. It meets anti-slip standards DIN 51130; Anti-slip R-11. Compatible only with vehicles without rear glass window. Not suitable for vans with tailgate.

- es Escalera fija de acceso para la puerta trasera. Escalera fija para acceder al portaequipajes del vehículo de colocación sobre la puerta trasera de la furgoneta. Acabado en pintura rugosa anti-deslizamiento. Cumple normativa anti-deslizamiento DIN 51130; Anti-slip R-11. Compatible únicamente con vehículos sin puerta trasera acristalada. No compatible con portón trasero.
- fr Échelle fixe d'accès pour la porte arrière. Échelle fixe d'accès à la galerie montée sur la porte arrière des véhicules utilitaires. Revêtement en peinture antidérapante. Accomplissement de la Norme Anti Derapante DIN 51130; Anti-slip R-11 Compatible uniquement avec les véhicules sans porte arrière vitrée. Pas compatible avec les véhicules avec hayon..
- de Feste Hecktürleiter. Feste Leiter für den Zugang zum Gepäckträger am Fahrzeug mit Anbringung an der Hecktür des Lieferwagens. Oberflächenbeschaffenheit: Anti-Rutsch schwarz strukturiert. Die Leiter erfüllt die DIN-Norm 51130; Klasse der Rutschhemmung R11. Nur kompatibel mit Fahrzeugen ohne Hecktür mit Fensterscheiben. Nicht kompatibel mit Heckklappe.

... other languages 44

		↑ <sup>1</sup>	↓ <sup>2</sup> Max: <sup>2</sup>		
941-060	CRUZ rear door ladder type EF 120	1200	100	✓	— <sup>3</sup>
941-062	CRUZ rear door ladder type EF 150	1500	100	✓	— <sup>3</sup>
941-064	CRUZ rear door ladder type EF 180	1800	100	✓	— <sup>3</sup>

<sup>1</sup> mm, <sup>2</sup> Kg, <sup>3</sup> not suitable for vans with tailgate

- Pickling steel
- Oxsilan
- HQ Polymer class 2

- ←
- CRUZ Evo Rack Alu
- CRUZ rear door ladder type EF
- CRUZ straps

INDEX ←

## general accessories for roof racks

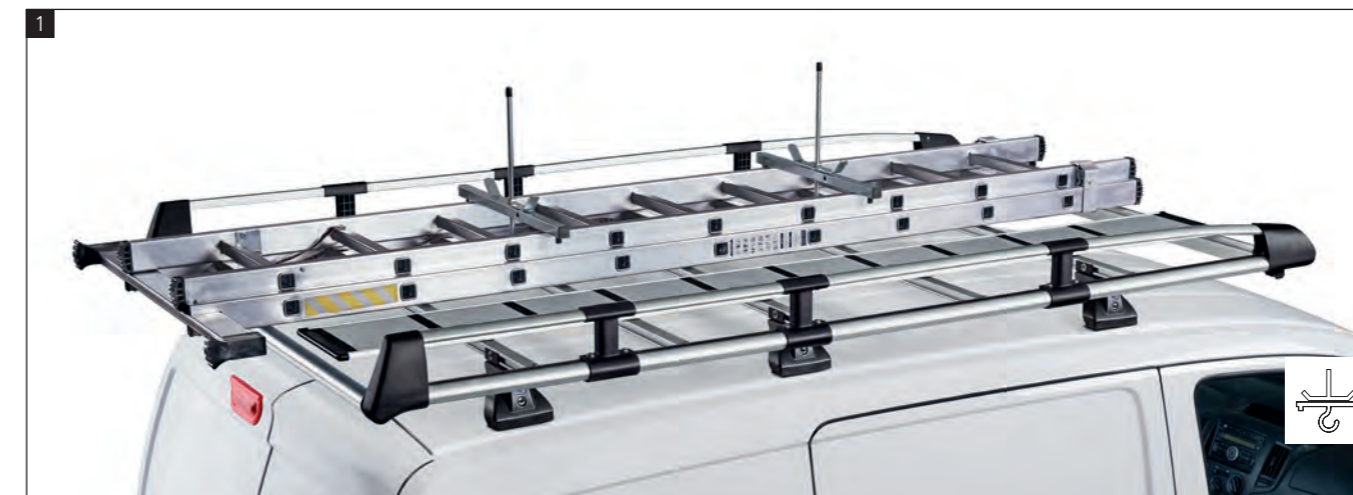

- 1 941-04x CRUZ ladder clamps
- 2 941-30x CRUZ straps
- 3 941-30x CRUZ ratchet straps
- 4 941-304 CRUZ ratchet strap with S hook
- 5 941-07x CRUZ rear door ladder type B









INDEX ←

CRUZ is the main supplier of transport systems for the leading renting–leasing operators and commercial van equipment companies in the Spanish market.



-  **CRUZ**  
industry-leading manufacturer and brand in Spain
-  **innovation**  
capacity for development and manufacturing of products
-  **customisation**  
adaptation of products to client's needs
-  **efficiency**  
quick service and reliable response

CRUZmedia  
cruzmedia.cruzber.com

support

**contact**  
@: aftersales@cruzber.com  
T: 0034 957 538 354  
M: 0034 639 343 733



follow us.





**[www.cruzber.com](http://www.cruzber.com)**  
roof racks & accessories

CRUZBER SA  
Pol. Ind. Las Salinas II, parc. 12  
E-14960 Rute (Córdoba) Spain

T: +34 957 538 354  
F: +34 957 539 069  
[info@cruzber.com](mailto:info@cruzber.com)



[www.facebook.com/cruzber](http://www.facebook.com/cruzber)  
[www.twitter.com/cruzber1963](http://www.twitter.com/cruzber1963)  
[www.instagram.com/cruzber1963](http://www.instagram.com/cruzber1963)  
[www.youtube.com/cruzber1963](http://www.youtube.com/cruzber1963)